

## EMISSIONS REDUCTION THROUGH HYDROGEN ENRICHMENT

Jean J. Botti, M. James Grieve, Carlton E. Speck  
Delphi Corporation, USA

*ABSTRACT – Hydrogen has unique properties in dilute combustion and catalytic reactions compared to other fuels. While the long-term vision for production and use of renewable hydrogen in transportation is theoretically attractive, significant economic and technical barriers remain in all areas. This paper will focus on two technologies which Delphi is developing to allow hydrogen to be produced and used on-board vehicles to capture the efficiency and emission control benefits of hydrogen in the short to mid-term. These technologies are:*

*On-board reforming for emission control with internal combustion engines (ICE)*

*Solid Oxide Fuel Cell (SOFC) for auxiliary power, heat and hydrogen generation.*

### INTRODUCTION

Hydrogen as a fuel for automotive internal combustion engines has had a long history of study in academic and industry circles. Hydrogen has unique properties with respect to combustion and catalysis. Hydrogen has very wide flammability limits compared to gasoline. Thus, hydrogen-fueled engines can operate under extremely high levels of dilution (either ultra-lean or with high levels of EGR) – allowing engine operation with high efficiency and low emissions. Hydrogen also greatly reduces exhaust catalyst light-off temperatures - enabling enhanced aftertreatment performance. While direct fueling of vehicles with hydrogen can offer extremely high efficiency with internal combustion engine hybrids [1], Delphi sees this as a relatively long-term option due to economic, technical and political barriers. On-board reformation can be employed to achieve

much of the benefit in emissions and efficiency without the short-term need for production, distribution and storage infrastructure for hydrogen. On-board reforming in emission control, fuel efficiency improvement and consumer functions would allow the sales volume and technical maturity of these hydrogen-utilizing systems to increase. This may result in an accelerated transition to direct hydrogen if, and when, the barriers are overcome.

Delphi Corporation has published extensively on its on-board reforming and SOFC programs. Integrating H<sub>2</sub> enrichment into an engine management system (EMS) enables SULEV emissions for larger / heavier passenger cars and trucks [2 – 8]. Compared to other SULEV approaches, this architecture permits a reduction in the size, precious metal loading and backpressure of the exhaust catalysts (which otherwise would be required for this extremely low emission level). Integration of an SOFC APU system allows notably higher efficiency for electrical generation compared to traditional on-board systems [9 – 12]. The SOFC APU will allow full electrification of accessories such as fans, pumps, blowers and compressors. This permits HVAC, lighting, entertainment, communication and battery charging functions to be independent of the ICE. While the use of reforming to enhance engine combustion and catalytic aftertreatment and the application of SOFC for efficient, on-board, engine independent electric power generation may be pursued as separate strategies, a substantial synergy may be exploited where the SOFC takes on the reforming function and becomes the source of syngas for the engine [13 – 15]. The very high marginal efficiency of syngas generation (due both to its generation as a co-

product with electricity and heat and to the use of waste heat in the stack to drive a substantially endothermic reforming process) allows integration of the SOFC into the propulsion system. This allows higher efficiency engine combustion – with ultra-lean combustion modes at light loads and extreme EGR modes heavy loads.

The deployment of these technologies into mass production would be important steps toward an economic and sustainable low CO<sub>2</sub> transportation - based on either renewable hydrogen or bio-alcohols. On the one hand, the co-fueling of reformed hydrogen in ICE and the use of SOFC for auxiliary power and in hybrid mechanizations, will build a fleet of vehicles, which could use direct hydrogen efficiently and economically. This could bring important economies of scale for hydrogen consumption as a renewable hydrogen infrastructure is created. On the other hand, the use of renewable alcohols (ethanol and methanol) is a viable pathway for reducing CO<sub>2</sub> in transportation. On-board reforming and SOFC technologies are expected to be very efficient and attractive ways of using alcohols – with greater benefits than the current practice of using alcohols directly (blended with conventional fuels) or an inputs to bio-diesel production.

This paper will first present observations of emissions reduction from a conventional gasoline engine when the engine is fed hydrogen-enriched fuel during cycle 1 of the EPA Federal Test Procedure. Results with both “synthetic” (bottled) reformat and reformat generated by a prototype on-board gasoline reformer will be included and compared. Next, the potential for additional efficiency improvements and CO<sub>2</sub> reduction will be presented for systems utilizing alternate, renewable fuels. Finally, an advanced vision for achieving ultra-low emissions in hybrid systems employing a SOFC auxiliary power unit (APU) with an ICE and/or an electric drive will be presented.

## REFORMER-ASSISTED INTERNAL COMBUSTION ENGINE OPERATION

One of Delphi’s SULEV strategies under development is H<sub>2</sub> enrichment. This approach uses an on-board gasoline reformer to produce H<sub>2</sub>-rich reformat for enabling very low vehicle emissions from a conventional spark-ignition engine. In the following, the fundamentals and advantages of enrichment are reviewed, and experimental results presented.

### FUEL REFORMING FUNDAMENTALS

Hydrogen may be made on-board a vehicle by combining fuel and an oxidant under very fuel rich conditions in a catalytic reformer. This produces



reformat (also called syngas) a gaseous fuel

Figure 1. Catalytic fuel reforming schematic.

containing primarily H<sub>2</sub> and carbon monoxide (CO). This is shown, schematically, in Figure 1.

The oxidant described above is usually air, but it may also be combustion products (water and carbon dioxide) as shown in Figure 2. Using air, the reaction is called catalytic partial oxidation reforming (CPOx). It is highly exothermic. This is convenient for small fast start-up devices – because the inputs can be delivered at low temperature and the heat released in the reforming reaction provides the sensible heat to keep the catalyst in an appropriate temperature range (about 1000 °C). Of course the downside to this is that the lower heating value of the syngas produced is, at best, 83% of the fuel delivered to the reformer – so there is an inherent loss in efficiency.

CPOx (Exothermic) Reforming (O/C = 1.000, 1000 °C, 83%)

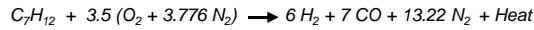

Exhaust Gas (Endothermic) Recycle (O/C = 1.715, 750 °C, 126%)

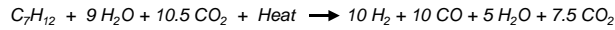

Figure 2. Nominal Reactions for Gasoline for CPOx and Exhaust Gas Reforming.

On the other hand, using stoichiometric exhaust gas as the oxidant requires a large input of heat into the process (to preheat the reactants and to supply the endotherm of reaction). It also requires a significantly larger catalyst volume and excess oxidant in order to work at practical temperatures. The upside is that this endothermic process delivers syngas with a higher lower heating value, which is about 126% of the fuel delivered to the reformer. This increase is due to the input of waste heat available in the system. So, waste heat must be available (in both quantity and at the right temperature) in order to realize this gain in efficiency at the system level.

Practical reformer devices may use a combination of these processes to realize an appropriate efficiency, size and dynamic range for a real application. For example, using lean engine exhaust as an input to the reformer is a method to deliver heated air + stoichiometric exhaust together.

### Fuel Properties

Table 1 compares selected combustion related properties of H<sub>2</sub> and CO to those of gasoline. It can be seen that properties of CO are often between those of hydrogen and gasoline – so reformat, which contains roughly equal amounts of H<sub>2</sub> and CO, will retain attractive properties compared to gasoline. These properties may be viewed for their impact on engine efficiency and exhaust emissions and aftertreatment. First, let us consider the impact

on engine efficiency. The high flame speed and low ignition energy of H<sub>2</sub> and reformat relative to gasoline, permit the use of very lean or high EGR operation. With lean operation, the engine can have high thermal efficiency because of an increase in the ratio of specific heats of the charge closer to that for air (k=1.4). The higher flame speed of H<sub>2</sub> and reformat helps to maintain combustion as near to constant volume as possible even with lean mixtures. Pumping losses are lower with H<sub>2</sub> or reformat relative to gasoline due to the lower energy density of H<sub>2</sub> and CO (in addition to the high dilution tolerance). This contributes to better efficiency at part load. The high spontaneous ignition temperature of H<sub>2</sub> and CO (coupled with the high flame speed) permit the use of higher compression ratios to boost the thermal efficiency further [7]. Second, let us consider the impact on emissions. Ultra lean or highly dilute combustion results in low peak cycle temperatures and very low NO<sub>x</sub> emissions. Lean operation can also result in low CO

Property	Gasoline	H2	Carbon Monoxide
Lean limit equivalence ratio in air	0.58	0.1	0.34
Flammability limits (volume %)	1.2-6	4-75	12-74
Laminar flame speed (m/s)	0.37-0.43	1.9 – 2.7	~ 0.4
Spontaneous ignition Temperature (°C)	280-400	574	609
Net energy density (MJ/m <sup>3</sup> )	202	10.3	12.6
Quench distance (mm)	~ 2.0	0.64	-
Minimum ignition energy (mJ)	0.24	0.02	-
Light off Temperature (°C) over platinum based catalyst	~ 270	~ 30	~ 220

emissions. H<sub>2</sub> or reformat fueled engines have

Table 1. Comparative properties of gasoline, hydrogen and carbon monoxide.

low and non-reactive HC emissions (related to light hydrocarbons that survive the reforming process and to lubricating oil). Furthermore, smoke (particulate matter) should also be extremely low. When blended with gasoline, H<sub>2</sub> and reformat can help reduce the HC emissions by decreasing the quench distance for better flame propagation in crevices. In terms of aftertreatment, H<sub>2</sub> and reformat are attractive for catalyst heating and light off, because they can be more easily and complete reacted on a catalyst. Thus, a rapid catalyst light off with minimal emission breakthrough should be possible with reformat added to the exhaust during startup.

#### HYDROGEN ENRICHMENT STRATEGY

Delphi's hydrogen enrichment strategy with an on-board reformer (see Figure 3) uses attributes of reformat to augment (not replace) a 3-way catalytic aftertreatment system. Briefly, the hydrogen enrichment strategy during cold start consists of:

- fueling with 100% reformat during cold start for near-zero engine-out HC and NO<sub>x</sub>;
- reacting reformat and air in the exhaust during cold start for rapid exhaust catalyst light off.

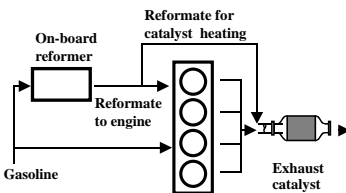

Figure 3. Schematic of the on-board reformer system.

#### EXTENDED HYDROGEN ENRICHMENT TESTS

Encouraging results in the emission reduction capability of H<sub>2</sub> enrichment have been reported in earlier Delphi publications. More recently,

Delphi has integrated a prototype reformer into a vehicle and demonstrated the benefits on a full US FTP emission test. The results are described in the following:

#### Baseline Testing

The test bed for the extended tests was a 2002 Chevrolet Trailblazer. Baseline emissions were evaluated using the Environmental Protection Agency (EPA) Federal Test Procedure (FTP) with gasoline fueling. For baseline testing the vehicle had its original engine management system (EMS) and its original equipment (OE) exhaust after-treatment catalytic converter. The converter had a relatively fresh catalyst with approximately 3000 miles. Figure 4 shows the cumulative (HC) and (NO<sub>x</sub>) emissions for the first 18 cycles of the FTP test. As indicated in Figure 4, the major fraction of the emissions occurs during the first cycle. The total HC emissions in this test were 63 mg/mi and the first cycle emissions were 54 mg/mi. This represents 86% of the total HC emissions emitted in the first cycle. The total NO<sub>x</sub> emissions in this test were 95 mg/mi and the first cycle emissions were 65 mg/mi. This represents 68% of the NO<sub>x</sub> emissions emitted in the first cycle. These HC and NO<sub>x</sub> emissions levels are well in excess of the SULEV standard of 10 mg/mi and 20 mg/mi for HC and NO<sub>x</sub> respectively. Since reducing emissions in cycle 1 has a disproportionate impact on total pollutants, the focus of this work was on reducing cycle 1 HC emissions using reformat fueling.

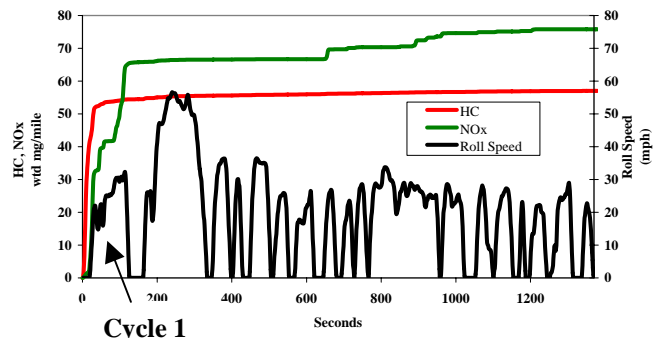

Figure 4. Cumulative HC and NO<sub>x</sub> Tailpipe Emissions FTP.



### Reformate Fueling

Reformate testing was conducted in two parts. Firstly, the system was set-up so that the vehicle could be fueled with bottled reformate. The bottled reformate was a blend of 21% hydrogen, 23.5% carbon monoxide and the balance was nitrogen. This simple blend simulates the mole fractions of the main components of reformate made from the fuel reformer system. In order to set-up for reformate fueling the vehicle engine management system (EMS) had to be modified so that there was communication between the vehicle and the reformate controller. Figure 5 shows a plot of the roll speed during the first cycle of the FTP test. During reformate tests, reformate is fueled to the engine at crank and through approximately 120 seconds of the test. Reformate fueling stops at the beginning of the final deceleration in the first cycle of the test. There are portions of the first cycle when the reformate flow is unable to supply the required power. During those portions, gasoline fuel supplements the reformate fueling. After the first cycle the vehicle is fueled with gasoline alone for the rest of the test.

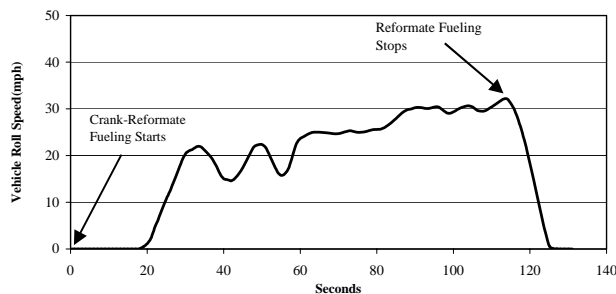

Figure 5. FTP First Cycle Reformate Fueling Strategy.

The second part of the reformate testing was conducted with a gasoline fuel reformer system making reformate on-line using partial oxidation catalytic reforming. In this system gasoline and air are supplied to the reformer system where a partial oxidation catalytic reformer converts the fuel to reformate. During steady state conditions the hydrogen and carbon monoxide concentration exiting the reformer were approximately 22 and 23%, respectively. Figure 6 shows a schematic of the components associated with the fuel reformer system.

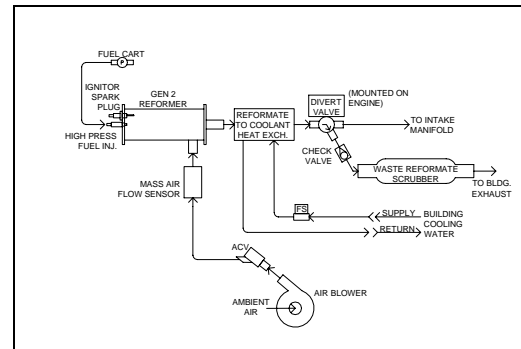

Figure 6. Prototype Gasoline Fuel Reformer and Test Configuration.

When the system was tested with the gasoline fuel reformer system the reformer was started and allowed to reach steady state reformate production prior to starting the emissions test. During this stabilization period, reformate is diverted to the waste reformate scrubber. At the start of the test the divert valve is activated and reformate flows to the intake during engine crank. Figure 7 shows a picture of the vehicle and associated reformer system hardware.

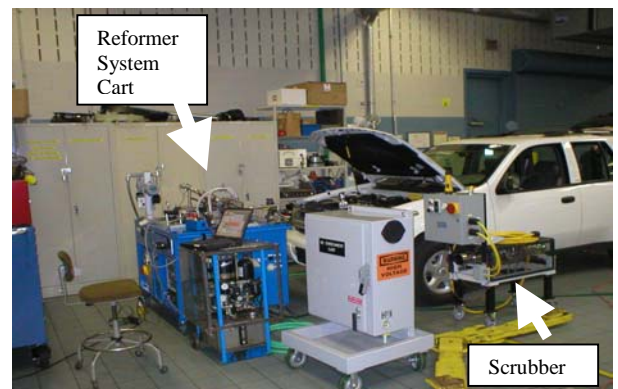

Figure 7. Vehicle and Reformer System Hardware.

After the baseline testing was completed emissions tests from three configurations were evaluated as part of the confirmation testing. Table 2 gives a brief description of these test conditions. For these confirmation tests the EMS was modified to enable reformate fueling and the exhaust after treatment system was replaced with a catalytic converter that had been aged for the equivalent of 100,000 miles. This converter was moved approximately twelve

inches closer to the engine to allow for faster warm-up.

Configuration #	Description
1	Delphi EMS and Calibration with close coupled aged converter (100k mi equivalent), gasoline fueling
2	Delphi EMS and Calibration with close coupled aged converter (100k), bottled reformat fuel
3	Delphi EMS and Calibration, close coupled aged converter (100k), reformat fuel made from reformer

Table 2. Confirmation Test Conditions

Figure 8 shows plots of the total HC emissions versus time for the first cycle of the FTP test using the 2002 Chevrolet Trailblazer. Total HC emissions during the first cycle of the test were reduced from 54 mg/mile to 8 mg/mile using bottled reformat fueling during this cycle. HC's are emitted during the first cycle even during reformat fueling. As indicated previously, gasoline fuel supplements the reformat fueling starting at the first acceleration in the test cycle. This accounts for some of the additional HC's emitted in this cycle with reformat fueling. When using reformat generated by the reformer the emissions were reduced to 9 mg/mi. This is higher than the result with bottled reformat. This is due to the fact that the reformer produces other constituents including some HC's that are not present in the bottled reformat. As a result, bottled reformat is more effective at reducing overall HC emissions.

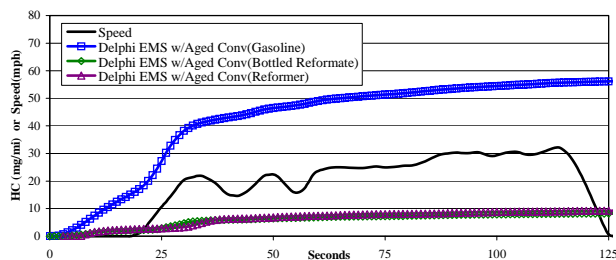

Figure 8. Weighted Tailpipe HC Emissions – First Cycle of the FTP Test

As shown in Figure 9, reformat fueling does not have as large an impact on NOx emissions

in the first cycle. Total NOx emissions during the first cycle of the test were reduced from 38 mg/mi to 30 mg/mi using reformat supplied by the reformer. With bottled reformat the NOx emissions at the end of cycle 1 was 45 g/mi. This is higher than the test with the reformer and even higher than the test with gasoline fueling. Using bottled reformat, the NOx emissions showed lower NOx early into the cycle; however, there was a continuous increase in NOx emissions through the remainder of the cycle resulting in 45 mg/mi at the end of cycle 1. For the reformer test, the tailpipe NOx emissions at the end of the first cycle were the lowest. Unlike bottled reformat, reformat produced by the reformer contains some CO2 and water as by-products. These serve as added diluents in the engine. Figure 10 shows the engine out NOx emissions for the tests. These added diluents might explain why the engine-out NOx levels were lowest with the reformer. Like the tests with bottled reformat, the tests with the reformer show a positive slope in tailpipe NOx throughout the first cycle. This indicates lean fueling for the reformer tests leading to incomplete NOx conversion across the exhaust catalyst. With reformat fueling, especially when the fueling is supplemented with gasoline, there is considerable work yet to do to improve air/fuel control.

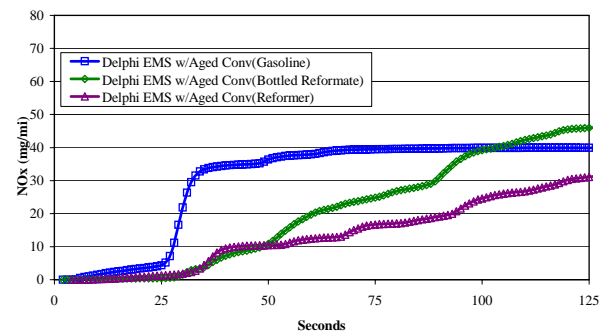

Figure 9. Weighted Tailpipe NOx Emissions - First Cycle of the FTP Test.

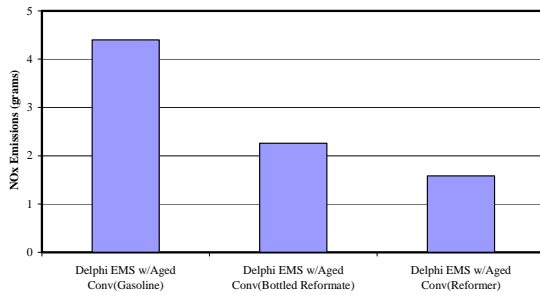

Figure 10. Engine Out NOx Emissions - First Cycle of the FTP Test.

Figures 11 and 12 show the HC and NOx emissions summaries for the test conditions that were evaluated. Cycle one HC emissions are reduced from 54 mg/mi with gasoline fueling to 8mg/mi with reformat fueling with bottled reformat. With the reformer the first cycle HC emissions were 9 mg/mi. HC emissions for the total test are reduced from 87 mg/mi to 52 mg/mi using bottled reformat. With the reformer the total test HC emissions were 49 mg/mi. Non-methane HC emissions for the total test were 27 and 28 mg/mi for the bottled reformat and the reformer tests respectively.

The NOx reductions observed in Figure 12 for the total test for the reformat fueling conditions are clearly related to conditions beyond cycle 1 and are not related to reformat fueling. Additional work, focusing on calibration and air/fuel control for NOx emissions will be required to address these issues.

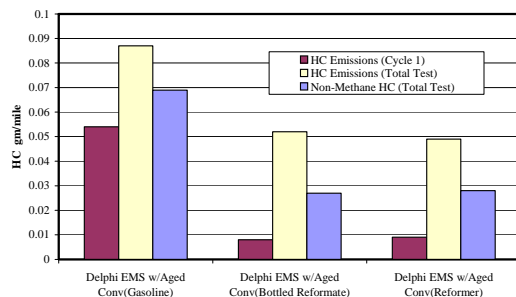

Figure 11. Tailpipe HC Emissions Summary.

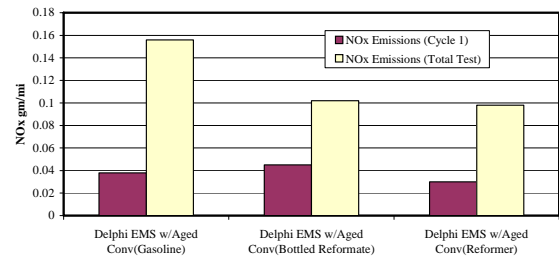

Figure 12. Tailpipe NOx Emissions Summary.

### EFFICIENCY AND EMISSIONS IMPROVEMENTS WITH RENEWABLE FUELS

The primary focus of a CPOx-based H<sub>2</sub>-enrichment system is start-up emission control and accelerated catalyst and engine warm-up. The loss in efficiency of CPOx reforming is mitigated by the ability to run the engine lean and essentially unthrottled and by the ability to recover by-product heat (to speed the passenger compartment and engine warm-up). In comparison, traditional methods of accelerated catalyst heating (for example spark retard and rich fueling with secondary air) tend to cause a small loss in fuel efficiency over the drive cycle – so some compromise to fuel economy is expected to meet emissions during a cold start. H<sub>2</sub>-enrichment is likely to be comparable or slightly better than traditional methods.

During warmed-up conditions, where the engine is normally constrained to stoichiometric operation (and EGR is the diluent), the small gain in efficiency allowed by higher EGR rates (enabled by H<sub>2</sub> enrichment) is normally less than the loss in fuel lower heating value due to CPOx reforming. Thus, it would be most desirable to shift towards a more endothermic reforming process under warmed-up conditions. If fully endothermic reforming with exhaust gas is used (as shown in the second equation of Figure 2), the gains in engine efficiency (with higher EGR) would be compounded by the gains in fuel lower heating value for the fraction of engine fuel which is reformed. Unfortunately, with gasoline (and even more so with diesel engines) the exhaust gas is often too

low in temperature to allow endothermic reforming with a practical reformer size. So fully endothermic exhaust gas reforming will be limited to very high engine loads and stoichiometric or near-stoichiometric engine operation for these fuels.

Substitution of alcohol fuels (either methanol or ethanol) as the reformer input allows fully endothermic reforming at as little as 250 °C. This temperature is almost always available in the exhaust of a gasoline engine. A flex-fueled (alcohol/gasoline) system could provide the SULEV cold-start advantages with either fuel and enhanced fuel efficiency when using alcohol blends. As alcohols can be made economically from renewable (biomass) sources, the CO<sub>2</sub> benefits of blending of alcohol fuels into conventional road fuels is well established. But the ability of efficiently reforming the alcohol to enhance the engine efficiency compounds the CO<sub>2</sub> reduction benefit.

## DELPHI'S POWERTRAIN VISION

### BACKGROUND

Delphi has been doing R&D on fuel cells since 1990. A solid oxide fuel cell (SOFC) program began in 1999 with a customer-linked program to develop a 3-5 kW auxiliary power unit (APU) product for luxury passenger cars running on gasoline. The first proof of concept was completed in late 2000. While other developers have shown Hydrogen PEM APU concepts for heavy-duty trucks, SOFC has significant advantages by being able to operate on gasoline, diesel or natural gas as well as (in the long term) hydrogen. Fuel is still reformed to syngas (a mixture of hydrogen and carbon monoxide) but the reformat requirements are much less severe than for PEM. The simple, 1-step reforming process previously described for H<sub>2</sub> enrichment can be used. For system start-up the CPOx reforming process is attractive, but it is possible to migrate to a fully endothermic reforming process during warmed-up operation of the SOFC. This is because the fuel cell runs at

constant temperature of about 800 °C. This is above the temperature required for endothermic reforming of conventional fuels.

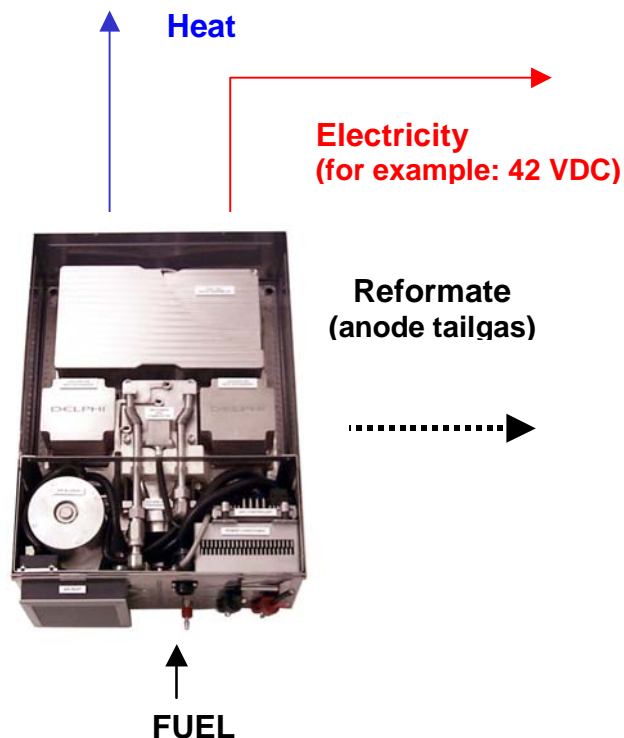

Figure 13. Prototype SOFC APU, showing 3 potential products

Thus, it is possible to use waste heat from the stack to drive the endotherm of reaction for the fuel reformer. Key to SOFC's efficiency and future applications is the fact that the SOFC inherently makes 3 products: electricity, hydrogen-rich syngas and high grade waste heat (see Figure 13). This has been part of Delphi's vision for SOFC since the beginning of our program. A well thermally integrated system can make some syngas as a by-product at high electrical loads at essentially zero marginal cost (because there is extra waste heat generated at stack temperature compared to the internal needs for reformat in the SOFC system). Additional syngas can be easily made (to match the requirements of the engine or aftertreatment system) by modulating the instantaneous power of the SOFC or by increasing the throughput of the reformer. Looking only at electricity, the efficiency of SOFC has clear advantages over conventional engine driven electric generators.

But taking credit for the by-product syngas and, again, for its compounding benefit to engine efficiency makes SOFC an even more compelling alternative. In addition to the electric power and by-product syngas the exhaust of the SOFC still is relatively hot and may be very valuable for premium vehicle heating functions. Thus, while today's research focuses on the SOFC as an APU for powering electrical accessories, our vision is to utilize the SOFC APU in a new family of hybrids that achieve additional gains in performance, fuel economy, and emissions.

The SOFC APU is a practical first step for introduction of fuel cells in transportation. But its linkage to luxury functions, (like electric air conditioning) instead of propulsion and its use of conventional fuels, instead of direct hydrogen may make it seem like a timid first step. However, a variety of future integration strategies for combined cycle SOFC/ICE, SOFC hybrid vehicles and, of course, the SOFC/Li-Ion range extender EV offer a wide spectrum of future "green" applications. In addition, the SOFC is capable of burning hydrogen or other renewable fuels efficiently. So low or zero net CO<sub>2</sub> vehicle systems can be conceived using SOFC with hydrogen or bio-alcohols – backed up by compatibility with conventional transportation fuels.

## SYSTEM MODEL AND PREDICTIONS

### SOFC / ICE hybrid vehicles

Figure 14 is a schematic that highlights Delphi's vision for an advanced propulsion system with inherently low emissions. As drawn it models a full series/parallel hybrid, but by deleting or scaling the emphasis of various components it can represent a soft or mild parallel hybrid or an electric vehicle in either a full series or range extender mode. The example hints at the predictions of modeling that replacing or substantially downsizing the battery in a hybrid vehicle with a SOFC can significantly reduce weight and space resulting in improved performance and fuel economy. A two-seater vehicle could become a four-seat one. Some

typical predictions for specific configurations follow.

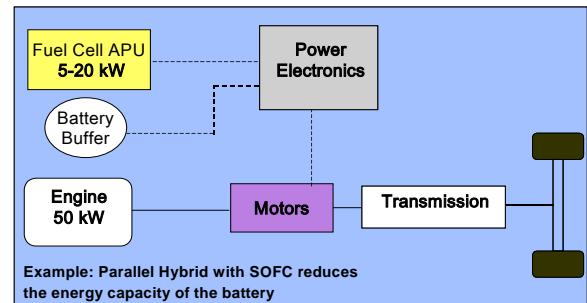

Figure 14. SOFC APU Plus Full Hybrid.

Preliminary simulation results predict that there is potential for excellent improvement in fuel economy when a SOFC APU is added to a full hybrid (see Figure 15). For example, gains of up to 60% can be expected if the unit is sized to allow full electric operation over the NYCC drive cycle (a severe, very low speed cycle). Optimization of the powertrain control strategy will also reduce emissions and fuel consumption in at least two ways:

- (1) an EV mode can be used where the ICE would otherwise be inefficient
- (2) by-product syngas from the SOFC could be used to fuel the ICE.

Furthermore, this SOFC reformate could significantly reduce cold start emissions of the engine as demonstrated earlier in this paper. Rather than completely replacing the battery, near term gains can be made by employing a small (3 – 5 kW) SOFC in conjunction with a higher power (35 kW) lithium battery or supercapacitor. This would reduce both the mass and volume of the battery and permit the elimination of the alternator. Finally, the high-temperature exhaust of the SOFC could provide high-efficiency heat to the vehicle's cabin during periods of cold weather, thereby eliminating the need to periodically run the engine to provide this function.

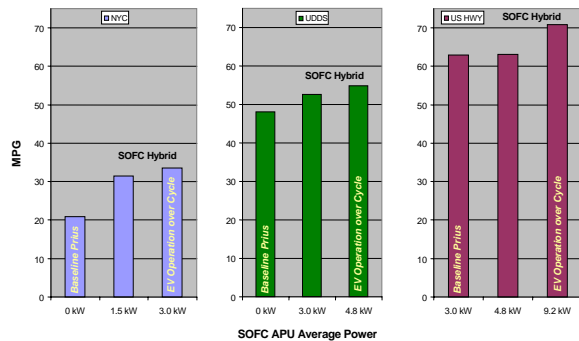

Figure 15. Results of simulation of SOFC hybrids applied to a hybrid vehicle similar to the first generation Toyota Prius.

### SOFC EV Range Extender

By adding an SOFC as an on-board battery charger to a standard plug-in electric vehicle, one can substantially increase the range and utility of the EV. Figure 16 shows typical predictions when it is assumed that a 10-kW SOFC APU is employed and a 100-kg lithium battery replaces the NiMH battery of the GM EV1. The model also assumes that the majority of the trips (85% of the trips and 60% of the miles) are in a pure EV mode where the energy was derived from the power grid, thereby being petroleum free (low net CO<sub>2</sub> emissions). It is predicted that through substantially reduced weight and increased on-board energy storage, the range is more than tripled. Fuel economy is improved by a factor of 11, compared with the PNGV goal of 3. In addition, 9500 W of high-quality heat is available for cabin heating or cooling. Another advantage is that the fuel cell can be run-on after the trip, thereby allowing the vehicle batteries to be recharged independently of the grid if required. In addition, the batteries can be kept warm in cold weather, thereby insuring power density and range. This configuration is one that could compete with a PEM fuel cell EV as a long-term, environmentally sustainable powertrain system. It is inherently near zero emissions, and is predicted to be 50% more efficient than the next best competitive system, a diesel engine APU series EV.

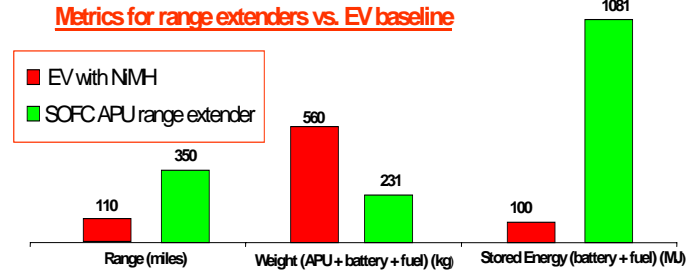

Figure 16. SOFC EV Range Extender Modeling Results

### Conclusion

- (1) Hydrogen has well known efficiency and emissions advantages as a fuel for fuel cell and ICE powertrains. While renewable hydrogen is an attractive long-term scenario as a significant transportation fuel, the generation and use of hydrogen on-board the vehicle brings numerous advantages for emissions, efficiency, economics and utility.
- (2) Catalytic partial oxidation reforming is attractive for fast start-up systems used for SULEV emission control functions for gasoline engines.
- (3) Exhaust gas reforming can be used to increase the efficiency of a super low emissions gasoline powertrain by recovering exhaust waste heat (in an endothermic reforming process) and by increasing the dilute limit of the engine.
- (4) Renewable alcohol fuels have significant advantages in their ability to be endothermically reformed at low temperature. Thus, a strong synergy exists between the use of on-board reforming technology for SULEV ICE and the deployment of alcohol fuel blends.

- (5) Solid oxide fuel cell systems are another user of on-board reformer technology. In addition to the high fuel-to-electric efficiency of the fuel cell itself, waste heat from the SOFC stack can be used in an endothermic reforming process. This allows the export of by-product syngas for use in ICE combustion and aftertreatment.
- (6) Relatively small SOFC systems can be used in a variety of hybrid electric vehicle configurations to improve efficiency, emissions and electric propulsion capability of the vehicle.
- (7) In addition to the ability of SOFC hybrids to use conventional fuels (gasoline and diesel), they are well suited to run on hydrogen or alcohols when these become economically available from renewable sources.
- (8) SOFC Range extender EVs also have the ability to use renewable or low CO<sub>2</sub> electricity from the grid to supply a substantial fraction of vehicle miles traveled for personal transportation. This type of vehicle is also compatible with conventional or renewable fuels. The economic incentive for reducing transportation fuel consumption will be the relative retail cost of electricity compared to the fuel, which would otherwise be used.

## References:

1. Aceves, S. Smith, R., "Lean-Burn Hydrogen Spark Ignited Engines: The Mechanical Equivalent to the Fuel Cell," ASME Fall 1996 ICE Conference.
2. Grieve, M. J., "Hydrogen Leveraging for Near Zero-Emission Vehicles with Conventional or Mild Hybrid Powertrains and Gasoline Fuel," Global Powertrain Congress, Detroit, MI, October, 1998.
3. Kirwan, J. E., Quader, A. A., and Grieve, M. J. "Advanced Engine Management Using On-Board Gasoline Partial Oxidation Reforming for Meeting Super-ULEV (SULEV) Emissions Standards," SAE Paper 1999-01-2927, August 1999.
4. Grieve, M. J., Kirwan, J. E. and Quader, A. A., "Integration of a Small On-board Reformer to a Conventional Gasoline Internal Combustion Engine System to Enable a Practical and Robust Nearly-zero Emission Vehicle," Global Powertrain Congress, Stuttgart, Germany, October 1999.
5. Kirwan, J. E., Quader, A. A., and Grieve, M. J., "An On-Board Gasoline Reforming System for Meeting SULEV Emissions Requirements in a Spark-Ignition Engine," Global Powertrain Congress, Detroit, MI, June 2000.
6. Kirwan, J. E., Quader, A. A., and Grieve, M. J., "Development of a Fast Start-up On-Board Gasoline Reformer for Near Zero Emissions in Spark-Ignition Engines," Aachen Colloquium on Automobile and Engine Technology (Aachener Kolloquium Fahrzeug- und Motorentechnik), October, 2001.
7. Kirwan, J. E., Quader, A. A., and Grieve, M. J., "Fast Start-up On-Board Gasoline Reformer for Near Zero Emissions in Spark-Ignition Engines," SAE Paper 2002-01-1011, March 2002.
8. Kirwan, J. E.; Quader, A. A.; Grieve, M. J.; Rahmoeller, K. M.; Wadumesthrige, K.; and Fisher, G. B.; "On-Board Reformer Development for Low Emissions in Spark-Ignition Engines," Global Powertrain Congress, Ann Arbor, MI, September, 2002.
9. Zizelman, J., Botti, J., Tachtler, J., Strobl, W., "Solid Oxide Fuel Cell Auxiliary Power Unit – A Paradigm Shift in Electric Supply for Transportation," Convergence 2000, SAE 2000-01-C070, Detroit, MI October 2000
10. Zizelman, J., Mukerjee, S., Shaffer, S., "Solid Oxide Fuel Cell Auxiliary Power Unit – A Development Update," SAE 2002-01-0411
11. Keegan, K. Khaleel, et al., "Analysis of a Planar Solid Oxide Fuel Cell based Automotive Auxiliary Power Unit," SAE 2002-01-0413
12. Mukerjee, S., Chick, L. et al., "Development of a Solid Oxide Fuel Cell Stack by Delphi and Battelle," based Automotive Auxiliary Power Unit," 8<sup>th</sup> International SOFC Symposium, Paris, France 2003
13. Botti, J. J., "The Revolution Through Evolution: Delphi Solid Oxide Fuel Cell for APU and Hydrogen Reformation," Powertrain International Magazine, November, 2002.
14. Quader, A. A., Kirwan, J. E., Grieve, M. J., "Engine Performance and Emissions near the Dilute Limit with Hydrogen Enrichment using

an On-Board Reforming Strategy,” SAE Paper  
2003-01-1356

15. Botti, J. J., Grieve, M. J., Miller, C. E.,  
“Power Generation System and Method,” US  
Patent 6,230,494 B1

*Contact.* Jean J. Botti, [jean.botti@delphi.com](mailto:jean.botti@delphi.com)